

1

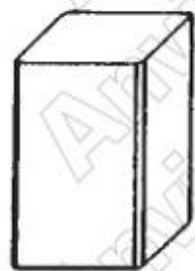

2

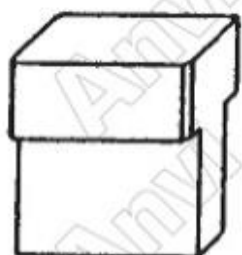

3

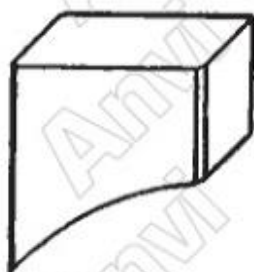

4



5

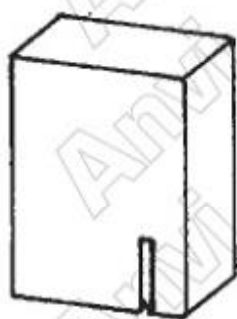

6

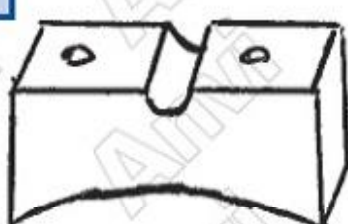

7

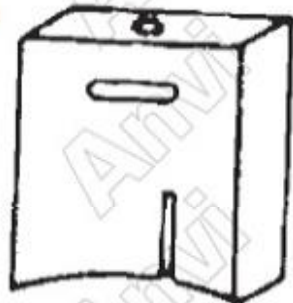

8

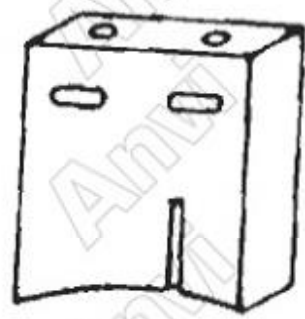

9



10

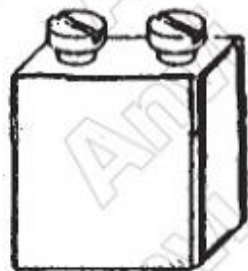

11

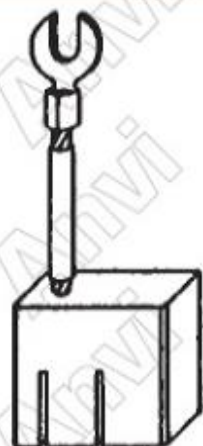

12

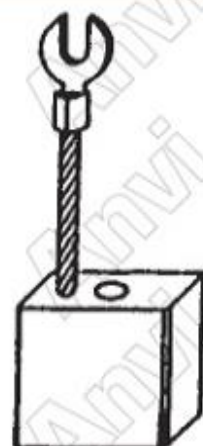

13

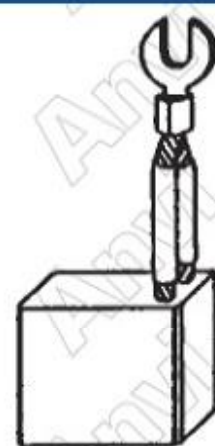

14

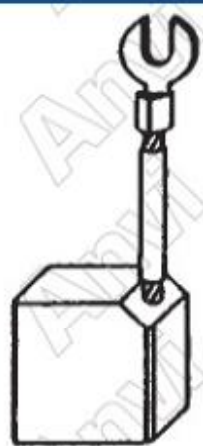

15



16

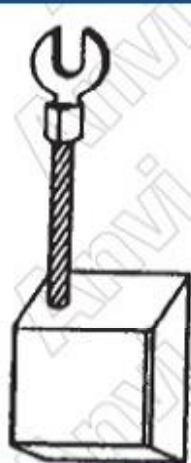

17



18



19

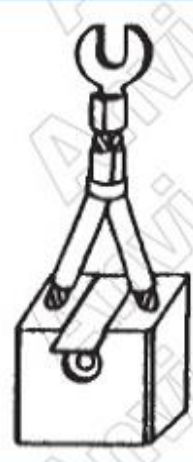

20

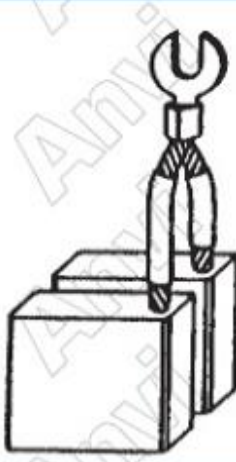

21

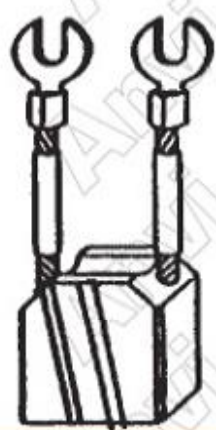

22

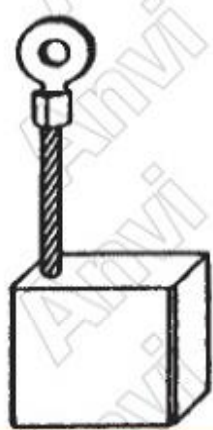







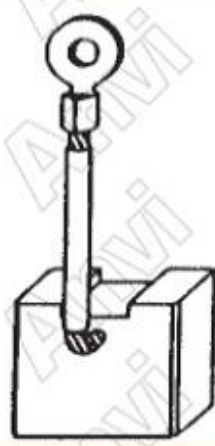

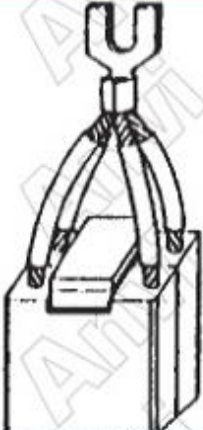

23

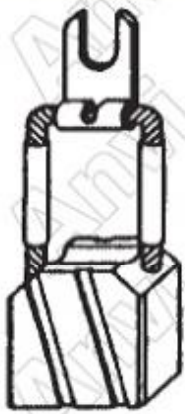
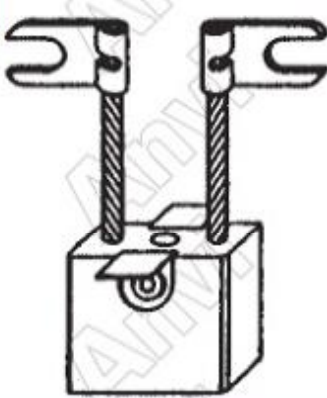
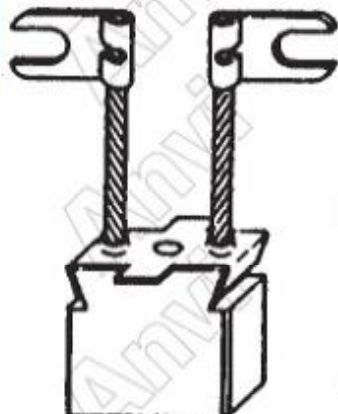
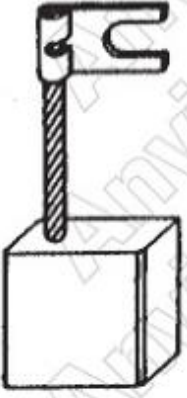

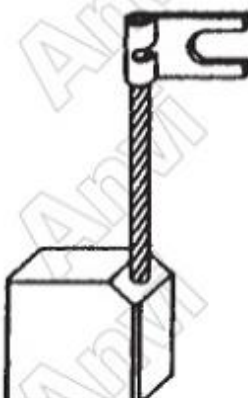
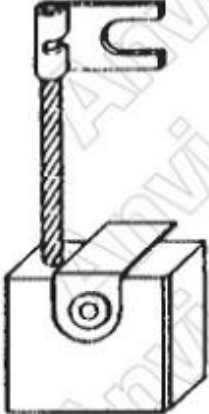
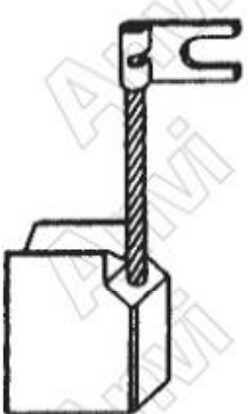
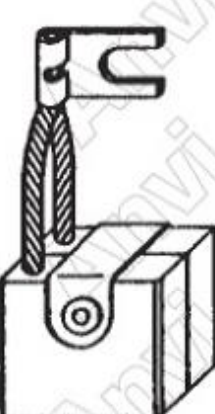
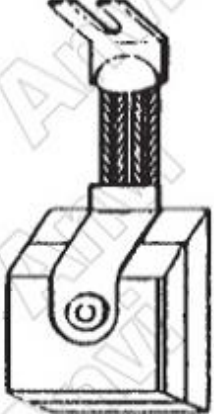
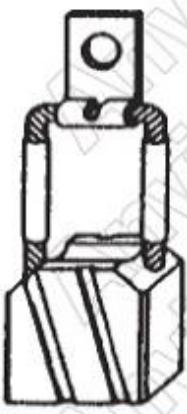
24

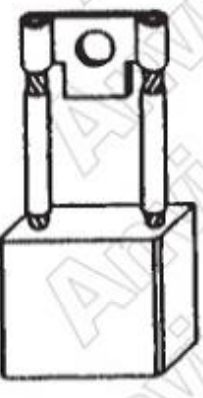
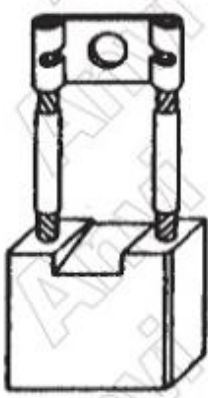
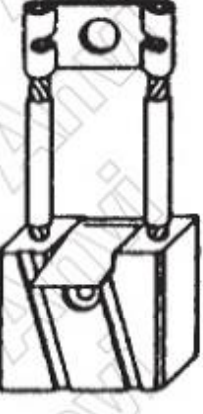
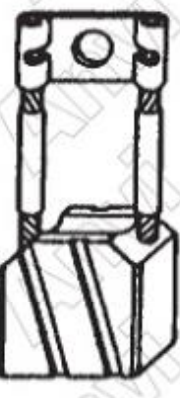

| | | | |
|---|---|---|---|
| <p>25</p>  | <p>26</p>  | <p>27</p>  | <p>28</p>  |
| <p>29</p>  | <p>30</p>  | <p>31</p>  | <p>32</p>  |
| <p>33</p>  | <p>34</p>  | <p>35</p>  | <p>36</p>  |
| <p>37</p>  | <p>38</p>  | <p>39</p>  | <p>40</p>  |
| <p>41</p>  | <p>42</p>  | <p>43</p>  | <p>44</p>  |
| <p>45</p>  | <p>46</p>  | <p>47</p>  | <p>48</p>  |

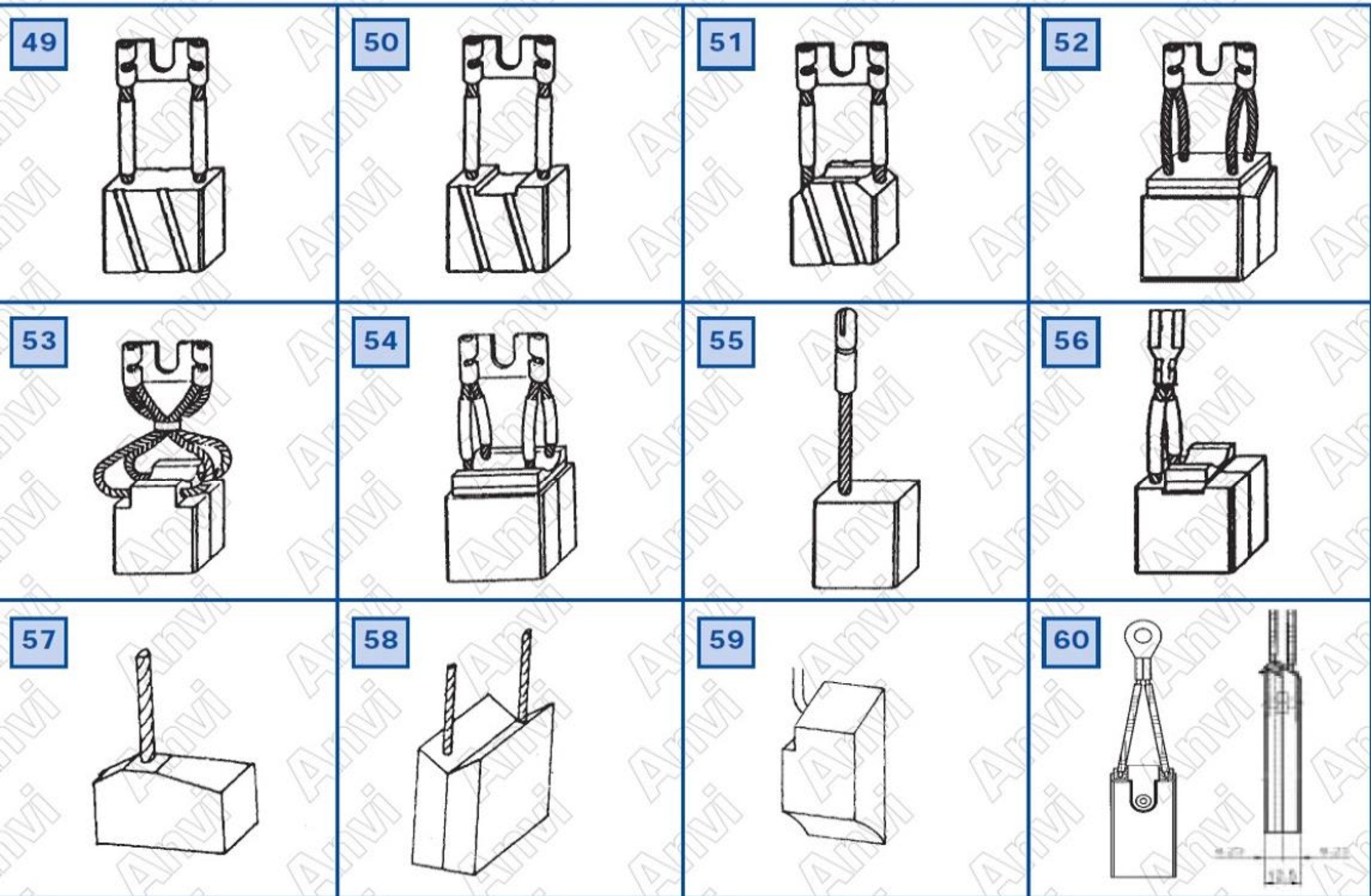

**CARBON ELECTRICO PARA CONTACTOS
FROTADORES DE PUENTE GRÚA
RULINAS PARA TRANSFORMADORES, ETC.**



PALETAS Y ROTORES PARA COMPRESORES Y BOMBAS DE VACIO

El carbón y el grafito, debido a sus propiedades particulares, son los materiales más utilizados para la fabricación de paletas y rotores, para compresores y bombas de vacío

TROWELS AND ROTORS FOR COMPRESSORS AND VACUUM PUMPS

The coal and the graphite, due to their particular properties, are the materials more used for the manufacture of trowels and rotors, for compressors and pumps of emptiness

PALETTES ET ROTORS POUR COMPRESSEURS ET BOMBES de VIDE

Le charbon et le graphite, étant donné ses propriétés particulières, sont les matériaux les plus utilisés pour la fabrication palettes et rotors, pour des compresseurs et des bombes de vide

